

RINGSPANN®

Press folder

2018 - 2019



Next stop Down Under

RINGSPANN is pursuing its globalisation plans at a breath-taking pace. Just a few weeks after the new branch in Singapore commenced activities, the company is announcing the establishment of its 14th international subsidiary RINGSPANN Australia. The German one-stop supplier of power transmission components, precision clamping fixtures and mechanical cable systems is thus intensifying its presence in the markets Down Under. From Melbourne, the company will especially focus on its mining and gear manufacturing customers in Australia, New Zealand and Papua New Guinea.

“Our strategy of internationalisation aims to establish RINGSPANN in all the important mechanical engineering regions of the world as a one-stop supplier for high-quality drive technology components – and always with our own employees on site. The now completed founding of RINGSPANN Australia is yet another systematic step in this direction”, says Nico Hanke, RINGSPANN’s International Head of Sales. Down Under, the German manufacturer can more easily and more quickly reach customers primarily in the fields of mining technology and industrial gear manufacturing from its new location in Melbourne. The vast distances in and between Australia, New Zealand and Papua New Guinea may remain a logistical challenge; but in Nico Hanke’s eyes, the advantages of RINGSPANN moving much closer to the major suppliers of mining technology in this industrial region dominated by mining with what is now its 14th foreign subsidiary far outweigh any risk. “We particularly anticipate a significant upturn in our MRO business, since the large coal and ore mine operators are now metaphorically right at our front door”, states Hanke.

Full access to international plants

Just like RINGSPANN Singapore, RINGSPANN Australia can also make use of all capacities of the manufacturing plants in Germany, Italy, the USA, China and South Africa. This ensures that Melbourne can competently and efficiently supply the customers in its large sales region south of the equator with

freewheels, shaft-hub-connections, overload clutches, industrial brakes, clamping fixtures and push/pull cable systems from the RINGSPANN portfolio. “Due to similar technology focuses, our parent plant in Bad Homburg as well as our production sites near Johannesburg in South Africa and Tianjin in China will be taking on a key role here”, explains Nico Hanke.

Slight upturn in sight

The establishment of another international subsidiary in Melbourne is proof that RINGSPANN cannot be slowed down by economic or structural crises of individual sectors in the implementation of its long-term internationalisation strategy. While the company’s market analysts are aware that the mining industry has been experiencing severe hardship for a number of years, they now see the first signs of a slight upturn. “With RINGSPANN Australia, we will be in the best possible position to take advantage when the mining business picks up again in this region of the world. Not only will we then be on the ground with our products, we will also be able to convince thanks to our consulting and engineering expertise”, stresses Nico Hanke.

While the employees at RINGSPANN Australia are poised to commence activities in the coming days, preparations have already begun in Bad Homburg for the next phases of the internationalisation strategy. We can look forward to seeing when the company will make its next announcement on the establishment of further foreign subsidiaries. <<

Seshan Ramaswamy
Managing Director
of RINGSPANN Australia



World premiere with precision right down to the thousandth

At the AMB 2018, RINGSPANN will once again be showcasing its position as an innovative premium supplier for the international machine tool industry in Hall 3. When it comes to issues of drive and clamping technology, the worldwide active company convinces with high-grade components that help mechanical engineers to realise highly-efficient precision solutions. This time, however, RINGSPANN will not just be exhibiting its precision clamping fixtures, shaft-hub-connections, torque and force limiters, brakes and friction torque limiters – for the first time, a new clamping clutch is also being presented for use in the driven rotary/tilt tables of multi-axis machining centres.

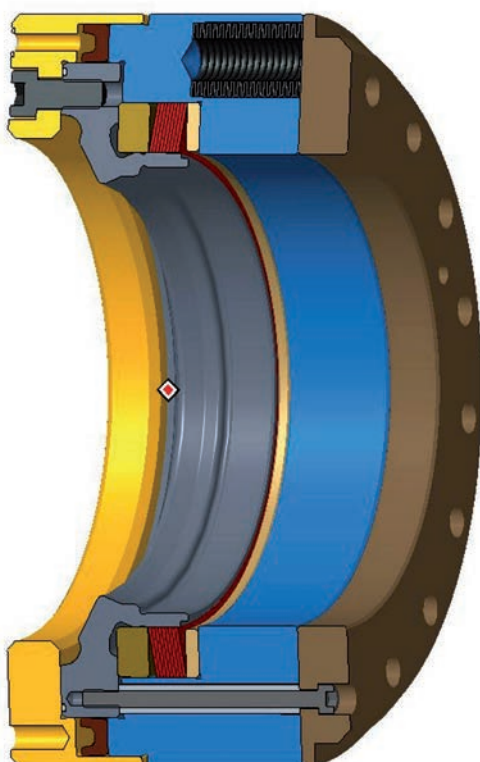

Volker Schlautmann
Head of Division Clamping
Fixtures of RINGSPANN GmbH



When it comes to mastering the three factors of power, dynamic and precision in modern multi-axis machining centres, the construction of workpiece holders and clamping elements play a key role. Continuously increasing demands on achievable accuracies and feasible torques are no longer a real surprise – least of all for suppliers. However, when a renowned mechanical engineer needed a high-precision solution to fix the driven positioning axes of the rotary/tilt table of a new five-axis machining centre, the challenge quickly separated the wheat from the chaff. After numerous manufacturers of clamping fixtures and clamping elements had to decline, the mechanical engineer came to RINGSPANN with its vision.

In the coordinate field of milling machines and machining centres, the rotary/tilt tables or portals form the A and the C-axis. Their function consists in enabling both a precise and quick approach of the workpiece to be processed into any angle setting. To achieve this, the positioning axes with the latest generation of rotary/tilt tables are driven by modern torque motors that can be controlled directly and with a high degree of precision. “And then, as soon as precise angle settings are to be held under stress during the highly precise simultaneous machining, these axes must be held – i.e. fixed. There are already clamping element solutions on the market that achieve this, however none meet the customer’s strict criteria”, explains Volker Schlautmann, the head of the clamping fixtures division at RINGSPANN.

August

“A real standout product”

Based on an existing clamping technology concept of RINGSPANN, an interdisciplinary team composed of engineers from the customer and RINGSPANN specialists took on the task. The team developed, tested and finally realised a new clamping clutch that convinced the mechanical engineer. And so, for the first time at the AMB at the RINGSPANN Booth C01 in Hall 3, it will be presented to a trade audience and as a world premiere represents the highlight of this year's trade fair programme. What is so unique about it: At torques of up to 2,400 Nm, the new clamping clutch guarantees a torsion angle of max. 0.007 degrees! “With these key technical parameters – and particularly with this level of accuracy – our new clamping clutch for rotary/tilt tables is a real standout product amongst the known fixing elements in this segment”, stresses Volker Schlautmann.

At RINGSPANN's AMB booth, trade fair visitors can have the operating principle of the new clamping clutch explained to them. One of the things they will discover is that it employs clamping discs from the RINGSPANN range to transfer the axial force of pressure springs into a radial force and feature a specially designed deformation element. “In this manner, we ensure the torsionally stiff clamping of the kingpin. The clamping is then quickly released by applying hydraulic pressure to the clamping clutch. The torque motor can subsequently freely drive the axle into any other angle setting”, explains Volker Schlautmann.

The new clamping clutch for rotary/tilt tables is now being produced in series and further enriches RINGSPANN's clamping technology portfolio. At the AMB, the company will however also be showing countless other components from this segment. Among them are precision clamping fixtures for the mechanical processing of cylindrical internal and external surfaces, which are widely available as standardised complete clamping fixtures. They are available in nine versions, so the customer can choose from four flange chucks and flange mandrels in the construction forms bonded disc, taper collet, taper sleeve, flat element and a taper collet centre mandrel. With true running accuracies of $\leq 10 \mu\text{m}$, these clamping fixtures are ideally suited for demanding tasks in machining technology.

The next highlight that RINGSPANN will be showcasing is the expanding sleeve mandrel HDDS developed in 2016, which represents an economically attractive alternative to hydraulic expanding clamping tools in gearing technology and fine machining. It stands out thanks to true running accuracies of $\leq 5 \mu\text{m}$, can take up workpieces with bores of up to tolerance

class IT10 and reduces the costs for feeding and positioning technology in fully automated operation. The HDDS range has since been augmented by an additional, smaller expanding sleeve mandrel, which means that bores from diameters of 22 mm (previously 32 mm) can now also be clamped.

Comprehensive range on display at the AMB

At this year's AMB trade fair stand, RINGSPANN will not only be presenting innovative components from its clamping technology division, but will also be inviting visitors on a foray



through its other product ranges for the machine tool industry. Because, as should be common knowledge by now, RINGSPANN offers among other things a wide selection of technical solutions for the secure operation of the main and auxiliary drives of tool machines and machining centres. Successful examples of this are the form-fit SIKUMAT® positive torque limiters and RIMOSTAT® friction torque limiters connected via friction lining. As overload protection for machine tool drives and spindles, they are ready for installation with various limit torques (0.5 - 10,000 Nm) and speed ranges (1,000 - 13,000 min⁻¹) to choose from. As overload protection

for push rods und drawbars, meanwhile, RINGSPANN's bi-directional acting force limiters are suited for disengaging forces of 3,600 - 140,000 N. A selection of overload clutches will also be on display.

A further focus of this year's AMB trade fair range is RINGSPANN's shaft-hub-connections connected via friction lining. Engineers and purchasers in the machine tool industry will find representative examples for all technically relevant types of these connection elements: externally clamping shrink discs for a play-free connection of hollow shafts and hubs on shafts, internally clamping cone clamping elements for the frictional connection of hubs on shafts, internally clamping star discs for applications with frequent switching between clamping and release, and star spring washers for the compensatory tolerance of ball bearings. Clamping systems for fixing torque motors on machine shafts connected via friction lining can also be found in this range. In total, RINGSPANN's shaft-hub-connections cover torques ranging from 0.16 Nm to 4,225,000 Nm.

Since RINGSPANN has also significantly expanded its brake range in the last few months on its way to becoming a one-stop supplier for high-grade components in drive technology, machine tool manufacturers at the company's AMB booth will also find numerous exponents from this segment. The electromagnetic disc brakes, which can be used for braking, holding and emergency stopping gravity-loaded and driven axles both from linear axles and rail guides, are bound to be a particular eye-catcher. The electromagnetic disc brakes from the EV and EH ranges particularly convince with lean installation dimensions, high degree of energy efficiency, low weight (from 6.5 kg) and numerous Industry 4.0 features (e.g. sensory monitoring). In the field of electrical brakes, RINGSPANN currently offers 16 basic types in four frame sizes with clamping forces ranging from 1,800 to 24,000 N; across all technologies, however, the industrial brake portfolio of the company covers braking torques from 0.5 to 600,000 Nm! <<



August

Via download directly into construction

With its new standard clamping fixtures RINGSPANN offers a low-priced entry into the world of precision clamping fixture technology. Furthermore, in order to allow all engineers in fixture and equipment design to easily incorporate these flange chuck and flange mandrel models into their CAD drawings, RINGSPANN is now making all data models available for free download on its website with immediate effect. They are now just a few clicks away from being downloaded in all common formats. Visitors to this year's AMB can find out more about this new service at the RINGSPANN booth C01 in Hall 3.

With this latest expansion of its download services, RINGSPANN is making life easier particularly for engineers of fixtures and equipment for manufacturing technology because, with immediate effect, the respective CAD models for all precision clamping fixtures of the eight standard models are now available for free download. With a minimum of effort, the engineer can now select the data model of the desired flange chuck or flange mandrel in the suitable format from the company's website, save it on their hard drive and incorporate it in their CAD drawing. And there are plenty of good reasons to do so in everyday practice: The engineer in fixture construction wants to be able to quickly incorporate a standard clamping fixture from RINGSPANN into his drawing as a complete CAD component, the equipment engineer may need to round off an already existing RINGSPANN clamping fixture with a backstop ring, an intermediate flange to the machine spindle or an adapter to the machine draw bar, and the project designer at the tool machine is able to resolve any issues on collision control. The direct link to the CAD models can be found here:

www.ringspann.com/en/downloads/cad-models/precision-clamping-fixtures



Aus dem Einsatz der CAD-Modelle können keine Haftungs- oder Gewährleistungsansprüche hergeleitet werden. Alle CAD-Modelle sind mit großer Sorgfalt erstellt, dienen aber lediglich der Veranschaulichung. Alle Rechte sind ausschließlich von RINGSPANN freigegebene Konstruktionszeichnungen.

n

Simple, quick and safe

The direct download of the RINGSPANN standard clamping fixture CAD models not only signifies an enormous reduction in workload and time savings for engineers; it also represents a significant contribution to quality assurance in construction. Not only is the manual reproduction of clamping fixtures in the CAD system naturally very time-intensive, it is also highly error-prone. Now, however, the full data models are ready on demand for all established CAD programs in all common formats. The engineer can select between CATIA (V4/V5), DXF and HSF as well as IGES, PARASOLID, STEP and SAT formats. The data formats VDAFS and VRML are also provided by RINGSPANN. Once downloaded, a data model can be used both to incorporate a complete standard clamping fixture of RINGSPANN into a complete device and for the constructional further processing of individual components.

Eight models for internal and external clamping

The new RINGSPANN range of standard clamping fixtures aims to provide users in the field of precision clamping fixture technology affordable and readily available comprehensive solutions. The focus of application hereby lies in the metal-cutting processing of workpieces with cylindrical internal and external surfaces – for example in gear manufacturing. Overall, the standard range of RINGSPANN consists of four models of precision clamping fixtures (flange chucks) and four models of precision clamping mandrels (flange mandrels). With their different construction forms - bonded disc (LAFF/ LBDF), taper collet (BKFF/ BKDF), taper sleeve (HKFF/ HKDF) and flat element (KFFF/ KFDF) - they represent different clamping principles. Thanks to their true running accuracies of ≤ 0.010 mm, they cover a wide range of cutting tasks and can be optimally tailored to the respective application in terms of clamping diameter, clamping length, insertion depth and expected wall thickness of the workpiece. <<

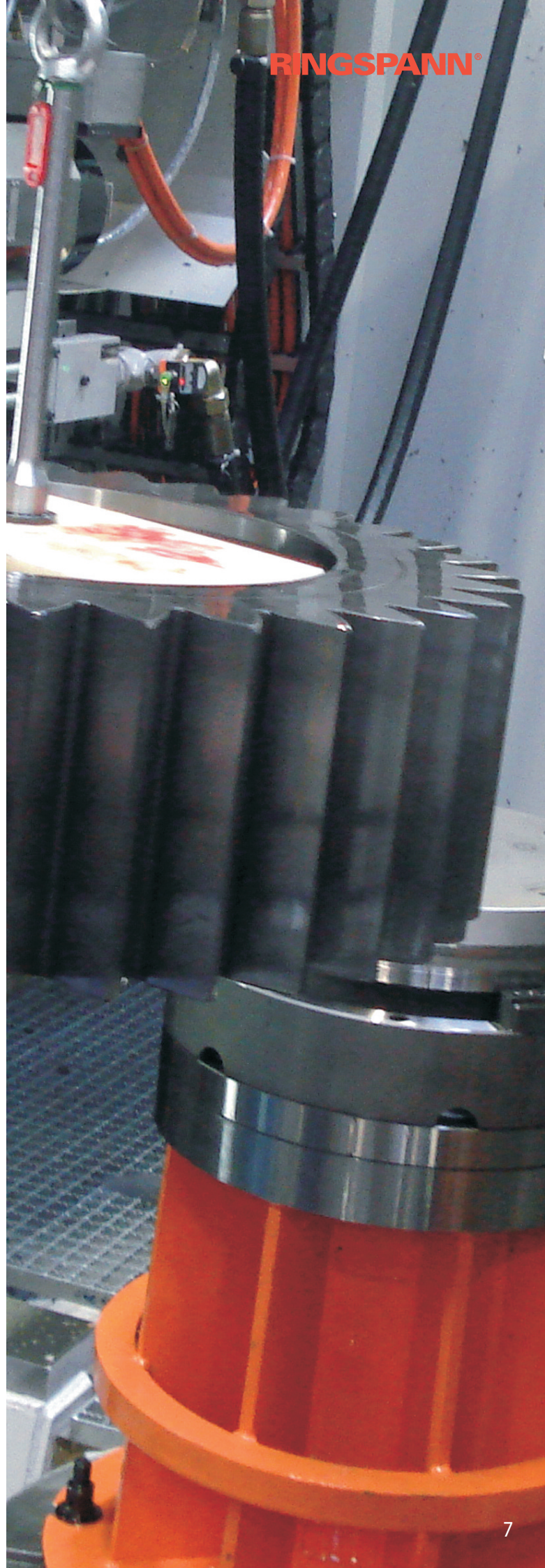

August

An offensive for more flexibility in the

RINGSPANN is beginning the second half of 2018 with a large-scale product offensive in the field of shaft couplings. The admission of five completely new coupling types and the supplementation of numerous existing models amounts to a massive expansion of the overall range. The full-range supplier is thus providing engineers and product developers in industrial drive technology with even more options for the realisation of safe, powerful and installation space-optimised connections between shafts, motors, gearboxes and machines. The new couplings will be on display publicly for the first time at this year's Motek, where RINGSPANN will be exhibiting in Hall 8 (Booth 416).

Barely a month goes by without RINGSPANN being able to announce the implementation of the next stage of its development towards becoming a one-stop supplier for high-grade drive technology components. Just a few days ago, the

Franz Eisele
Head of Division
Brakes and Couplings
of RINGSPANN GmbH



company's brakes and coupling division announced the massive expansion of its range of non-shiftable shaft couplings. It is important to realise that RINGSPANN has been devoted to the development and production of safety and starting clutches shiftable under load for more than 60 years. "However, this latest expansion of the product range is as yet unrivalled in the history of the company", stresses divisional manager Franz Eisele. While the focus of RINGSPANN's portfolio in this field had been previously placed primarily on flange, flexible and cone clamping couplings, the overall selection is now being expanded thanks to the current product offensive with five completely new models. What that means: With immediate effect, you can now also find gear couplings, grid couplings, disc couplings, pin-and-bush couplings and jaw couplings ready to deliver. "This range now allows us to offer a total of eight models that cover almost all technically relevant types of rigid, torsionally stiff and elastic shaft couplings that are currently needed in industrial drive technology", says Franz Eisele.

Eight models up to 1,299,500 Nm

Across all eight models, the now available RINGSPANN spectrum of shaft couplings covers an astonishing range of nominal torques from 2.0 to 1,299,500 Nm! This also means that purchasers and engineers from every conceivable industrial sector and branch now have a comprehensive range of non-



drive train

shiftable shaft couplings for applications in almost every area of drive technology available to them. Franz Eisele explains: "The beneficiaries of our comprehensive coupling range will not only be our current core target groups in conveyor technology, crane construction and gear manufacturing, but also many other plant manufacturers and mechanical engineers – for example those in fluid and process engineering, raw materials industry and steel production."

New catalogue for download

A complete overview of RINGSPANN's new portfolio of shaft couplings can be found in the freshly issued product catalogue 2018/19, which is available for free download on the company's website (www.ringspann.com). Here you find all coupling types and variants sorted according to design and area of application and described and depicted: The cone clamping couplings and tru-line flange-couplings for rigid connections; the gear, disc and flexible couplings for torsio-

nally stiff connections; the grid couplings for initially elastic and later torsionally stiff connections; and the pin-and-bush and jaw couplings for elastic shaft connections. "We offer the suitable coupling for applications in which the torque is transferred torsionally stiffly without phase shift but the shaft displacements need to be compensated, just like for applications in which a defined torsional stiffness must be ensured through elastomers. The coupling connoisseurs amongst us may miss the highly elastic elastomer coupling model; but we will soon be putting that right", says divisional manager Franz Eisele.

And what the customer has come to expect with freewheels, brakes, shaft-hub-connections, overload clutches, clamping fixtures and push/pull cable systems of RINGSPANN naturally also applies for shaft couplings: Customer-specific modifications can always be realised beyond the standard version shown in the catalogue to adapt series clutches to unusual and special applications. <<



September

Even more choice for drive technicians

Manufacturer RINGSPANN is using this year's SPS IPC Drives in Nuremberg to showcase numerous innovations from its current portfolio for industrial drive technology at its trade fair booth in hall 3. The one-stop supplier is placing the focus on new freewheels, new shaft couplings and its compact electrical brakes. The mechanical remote control systems of RINGSPANN subsidiary RCS will also be present.

A completely new freewheels series is one of the highlights of RINGSPANN's trade fair appearance at this year's SPS IPC Drives. "The product catalogue may not yet be ready to print, but our product range is already ready, meaning that we can present our new FZ series to a large audience for the first time at our trade fair booth 274 in hall 3", says Thomas Heubach, the divisional manager of freewheels at RINGSPANN. The unique thing about these freewheels is that they boast properties that one would commonly expect of bearings. It would

therefore not surprise Thomas Heubach at all if several trade fair visitors were to initially mistake the new FZ freewheels for ball bearings of a closed design. In purely visual terms, they do look deceptively similar to this ball bearings type, and yet functionally they fulfil very different tasks. Thomas Heubach explains: "They are bearing-supported internal freewheels that can be universally deployed as backstops, overrunning freewheels or indexing freewheels. In most sizes, we have designed them in the same dimensions as the series 62 standard ball bearing common in drive technology. They are installed into the housing provided by the customer, which enables the realisation of space-saving and compact designs."

To give engineers in drive technology as much freedom as possible, RINGSPANN offers the new freewheels in five basic versions with eight or nine sizes each for the transfer of nominal torques of up to 420 Nm (at the outer or inner ring). For applications in demanding conditions (dirt, wet etc.), two basic versions additionally feature 2RS seals.

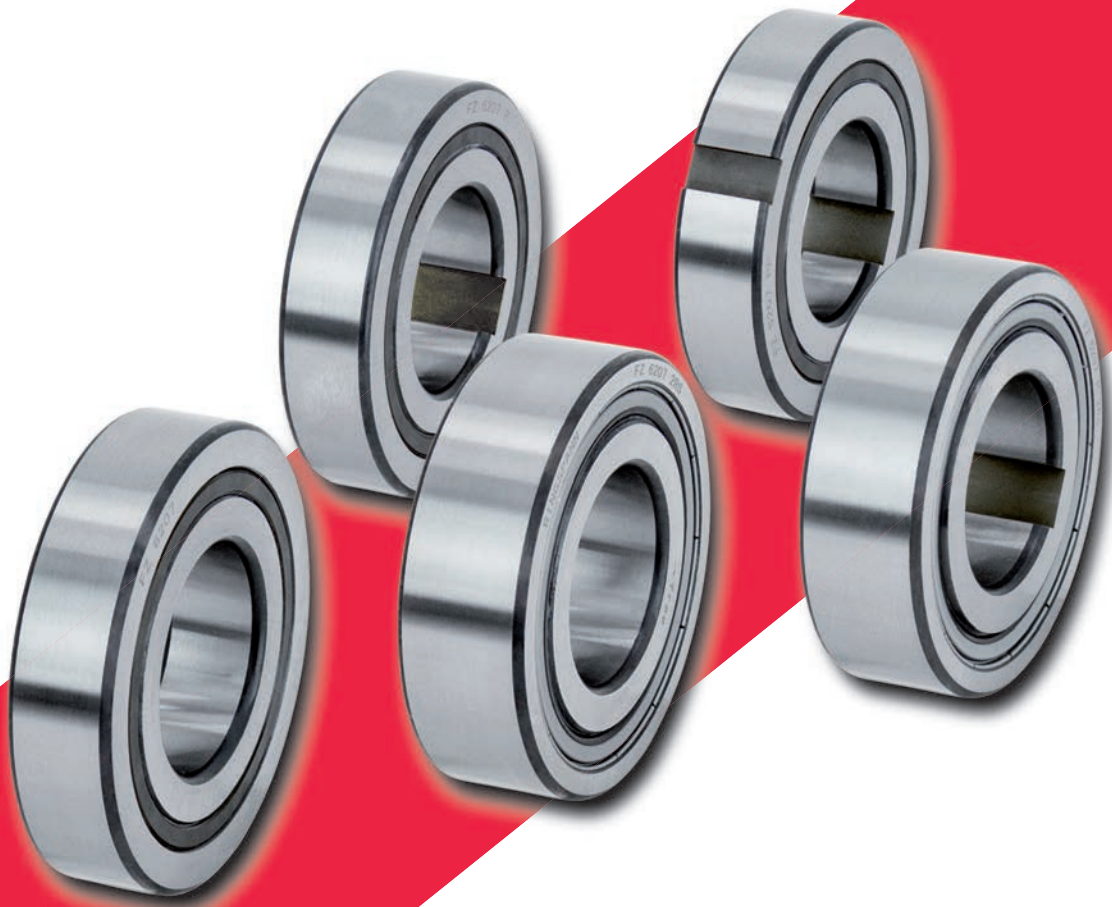



Thomas Heubach
Head of Division Freewheels
of RINGSPANN GmbH



Franz Eisele
Head of Division Brakes and
Couplings of RINGSPANN GmbH



Christian Kny
General Manager of
RINGSPANN RCS GmbH

Torques of up to 1,230,000 Nm

The FXM-series freewheels, designed for much higher torques – and significantly larger in size –, will also be presented by RINGSPANN at this year's SPS. They are integrated freewheels with sprag lift-off for bolting to the face, which can be used as backstops and overrunning freewheels for tremendous nominal torques of up to 1,230,000 Nm. "Typical areas of application are the gearbox constructions of conveyor belts, bucket conveyors or grinding mills", explains Thomas Heubach. The freewheels of the FXM series have bores with diameters of up to 560 mm.

Five new coupling series

A whole wealth of innovations will be on display by RINGSPANN at SPS in the field of shaft couplings. And that is because just a few weeks ago, this product area was significantly expanded with the addition of five new types and the supplementation of many existing series of non-shiftable shaft couplings. The current selection of flange, flexible and cone clamping couplings is supplemented by gear couplings, grid couplings, disc couplings, pin and bush couplings, and jaw couplings. "Our range thus now encompasses eight series that cover almost all technically relevant types of rigid, torsionally stiff and elastic shaft couplings that are currently in

demand in the industry", says divisional manager Franz Eisele. In total, the current RINGSPANN range of shaft couplings now encompasses nominal torques ranging from 2.0 to 1,299,500 Nm. This means that purchasers and engineers from every conceivable industrial sector now have access to a comprehensive range of non-shiftable shaft couplings for applications in almost every area of drive technology. Franz Eisele stresses: "The beneficiaries of our coupling range will not only be plant manufacturers in conveyor technology, crane construction and gear manufacturing, but also other mechanical engineers and systems manufacturers – for example those in fluid and processing engineering, raw materials industry and steel production." A complete overview of RINGSPANN's new portfolio of shaft couplings can be found in the product catalogue 2018/2019, which is available at www.ringspann.com as a download version – and will also be available at the company's SPS trade fair booth in hall 3.

Energy-efficient stopping and holding

Since RINGSPANN views itself as a one-stop supplier for premium components of industrial drive technology, the company will also be providing insight into its current range of electrical brake systems in Nuremberg. The focus will hereby be on the electronically controlled electrical disc brakes of the EV and EH series. They are a cost-efficient holding and emer-

September

gency stop solution for all mechanical engineers and plant manufacturers who shy away from the installation and maintenance expenditure of hydraulic or pneumatic brake systems. "It will not only be engineers of drive and rotating units who stand to benefit from the high level of functionality and energy efficiency of these compact industrial brakes, but ultimately also the systems' users and operators", says Franz Eisele, also responsible for the brakes division at RINGSPANN. The brakes in the EV and EH series are suitable for the realisation of both active and passive brake concepts, since they can be supplied in a spring-operated / electromagnetic-released version and in an electromagnetically operated / spring-released version. Furthermore, they can be mounted parallel or vertical to the brake disc, and adapted to brake discs with thicknesses ranging from 8 to 30 mm. "This offers broad freedoms in construction; especially in cases when it is not possible to freely define the brake disc thickness or to define it in advance", explains divisional manager Eisele.

Typical areas of application for these RINGSPANN brakes are for example the turbine, ventilator and fan industries, ma-

chine tool construction, winch and winding technology, the wind power industry and general drive technology. They are designed for supply voltages of 230 to 415 VAC (50/60 Hz) and are available in 16 basic types with clamping forces of 1.8 to 24 kN. A remarkable technical feature of the EV / EH brakes is that they make do with minimal power consumption throughout the entire holding phase; for the small sizes this means a mere 10 watts.

The electrical brakes of RINGSPANN also convince thanks to features that are of particular interest to the plant operator. The braking torque, for example, can be easily and precisely adjusted via an adjusting nut, and worn friction blocks are replaced in no time – since the brake does not need to be dismantled to do so. Furthermore, the sensory monitoring of the brake function (open/closed) and the degree of wear of the brake pad improve both the handling and the safety level. "With regards to Industry 4.0 applications, we have also ensured that the monitoring functions can be easily integrated into superordinate control systems of machines and systems", says divisional manager Franz Eisele.



The electrical disc brakes of RINGSPANN. They achieve clamping forces of up to 24 kN and are suitable as holding or emergency stop systems for many industrial applications. The figure depicts a EV024FEM-type brake.

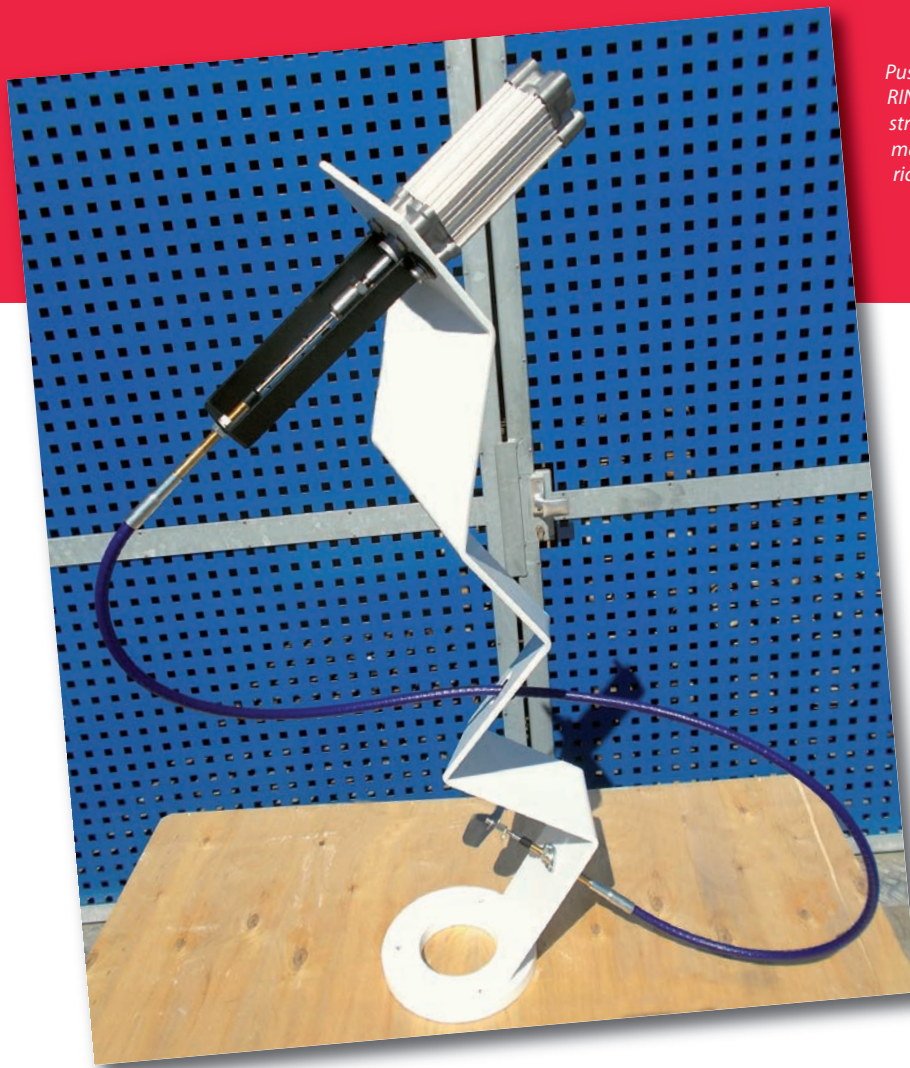

Push/pull cables from RINGSPANN RCS used as a stroke extension for pneumatic, hydraulic or electrical cylinders.

Forces transferred mechanically

To round off its trade fair appearance at this year's SPS, RINGSPANN will be showcasing various exhibits from its subsidiary RINGSPANN RCS, which is specialised in the manufacture of high-grade remote control systems. Here, it is push/pull cables particularly that – primarily for reasons of safety and energy efficiency – have long been subject to growing demand in industrial drive technology. They serve the alternating power transmission and are suitable for all applications where forces need to act between spatially separated, fixed modules – also and particularly when it must be possible to separate the connection of input and output force through a flexible system. The excellently crafted cable systems are intrinsically safe, maintenance-free, extremely flexible, protected against splash water and convince thanks to excellent sliding properties. They are – depending on the design – designed for very small bending radii and actuation cycles of 1.0 million and more.

At the RINGSPANN trade fair booth 274 in hall 3, the use of such a push/pull cable as a stroke extension of a cylinder is

depicted by means of a technical sculpture. "Such a cylinder can operate pneumatically, electrically or hydraulically; the force applied by it is transferred by our flexibly mounting cable system purely mechanically, free of disturbances and absolutely reliably", explains RCS managing director Christian Kny.

Continuous expansion

With this year's appearance at the SPS in Nuremberg, RINGSPANN once more marks its development from a traditional supplier to an international full-range supplier for high-grade components in industrial drive technology. This modernisation process began approx. three years ago, and has since been pursued unwaveringly by the company's senior management. At SPS, the RINGSPANN management will also be providing information on upcoming product offensives and the next steps with regards to the establishment of further international subsidiaries.



December

The extended arm of the cylinder



Christian Kny
General Manager of
RINGSPANN RCS GmbH

Everywhere in mechanical engineering and plant construction, pneumatic, hydraulic and electrical cylinders enable the automation of linear kinematics. However, it is not always possible to position the linear drive right at the heart of the action. Confined installation spaces, dirty surroundings and high temperatures can present an obstacle to this, just like risks of explosion and radiation exposure. In such cases, clever engineers turn to RINGSPANN RCS' mechanical push/pull cables. And that is because the flexibly layable remote control systems allow lifting forces of linear drives to be safely transferred across many metres. Read here about which projects the power cable specialists from Oberursel are currently working on.



Whether it's about the use of lean pneumatic and electrical cylinders in automation technology, or the use of strong hydraulic cylinders in machines in the construction industry or the coal and steel industry: Engineers everywhere find themselves confronted with the problem that power-inducing linear cylinders cannot be positioned right at the heart of the kinematic action. And there are plenty of reasons for this. Usually it is a lack of installation space and particularly demanding operating conditions (e.g. dust, heat, radioactivity) that force the spatial separation of drive and actuator. To get the necessary forces safely to their moving destination despite this, just ask the remote control system specialists at RINGSPANN RCS in Oberursel near Frankfurt am Main. They have worked on various different projects on specific system solutions where lifting forces – generated through pneumatic, electrical or hydraulic cylinders – are transferred mechanically via flexibly laid push/pull cables. "The groundwork to ensure that this can be carried out permanently free of disturbing influences and with a high degree of reliability is provided by decades of acquired expertise in kinematics and tribology, along with the daily practical work with the push/pull cables from our broadly diversified overall range", says Christian Kny, managing director of RINGSPANN RCS.

Refuse collection vehicles, concrete saws and robots

RINGSPANN RCS' projects, usually initiated by customers, address issues like how hydraulic cylinders of lifting and tilting devices of refuse collection vehicles can be kept out of the dirty area, or how concrete saws can operate efficiently without needing to upgrade their hydraulic linear drives to situate them in the dusty sawing zone. Christian Kny also makes reference to a highly ambitious innovation project: "For applications in industrial automation, we are currently focusing on how we can relieve the burden on the built-in drive modules of modern articulated and portal robots and instead control their kinematics from remotely positioned adjust cylinders via mechanical push/pull lines. The robot could then be greatly simplified from a constructional point of view, could be designed much lighter, and in fact would in fact act more quickly at the end of the day." Elsewhere, the specialists of RINGSPANN RCS are working on realising synchronised multi-cable systems that can transfer particularly large forces of hydraulic cylinders.

A million cycles and more

These kinds of engineering projects can only be carried out because RINGSPANN RCS' mechanical cable systems are high-grade manufactured, quality products. They are designed for more than 1.0 million cycles and convince thanks to excellent sliding properties. Furthermore, they are intrinsically safe, maintenance free, extremely flexible and protected against splash water. In general, they prove to be an ideal solution for all applications where forces need to act between spatially separated, fixed components, but where it must be possible to separate the connection of input and output force through a flexible system.

Depending on the model and depending on the stroke, bi-directional push/pull cables from RINGSPANN RCS can be used to transfer pushing forces of up to 3,150 N and pulling forces of up to 4,500 N. In practice, these standard values cover a broad range of applications. In project work, however, they often only serve as a rough orientation. "When developing and engineering customer-oriented system solutions, other design parameters often have a greater relevance – for example the continuous operation safety and functional safety, possible laying radii, response behaviour, or the suitable design of the end parts", stresses Christian Kny.

By the way: If there's no time to conduct a comprehensive development project, from certain batch sizes RINGSPANN RCS also offers the option of coordinating and configuring common standard types of its push/pull cables from the standard range to customer specifications. <<

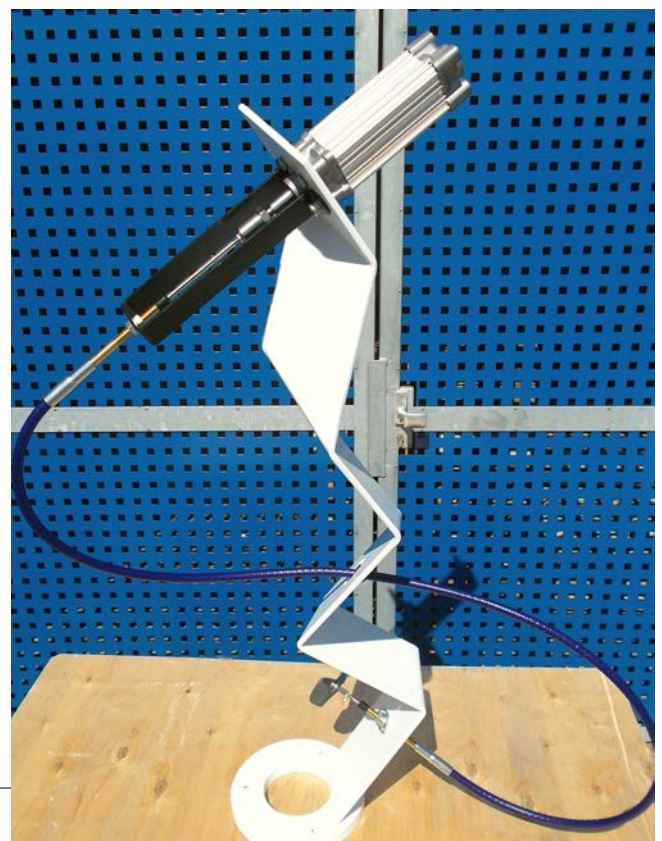

Visual twin at Hannover Messe

RINGSPANN's internal freewheels of the FZ series are suitable for nominal torques of up to 420 Nm and can be used as overrunning clutches, backstops and in the indexing function. What sets them apart is their compact design, featuring the same dimensions as the series 62 standard roller bearings according to DIN, making these freewheels a versatile, ideal solution for spatially optimised designs in the drive systems of packaging systems, food processing machinery, warehouse handling machines and conveyor belts. They are already being used for hybrid drive concepts, and they are among RINGSPANN's product highlights at this year's Hannover Messe.

"Time and again we find that even experienced designers mistake the internal freewheels of our FZ series for classic roller bearings", says Thomas Heubach, divisional manager of RINGSPANN's freewheels division. And it's no surprise that one could indeed at first glance mistake the compact machine elements with roller bearings of a closed design: They look deceptively similar and correspond de facto in their dimensions with the series 62 standard grooved ball bearings according to DIN. This outward similarity is of significant advantage, because it simplifies in many cases the design work and supports the realisation of spatially optimised fitting solutions. FZ freewheels can be used in drive systems as backstops, overrunning or indexing freewheels with nominal torques ranging from 9.0 to 420 Nm. And they combine roller bearing characteristics with freewheel functions: The bearing turns – as if moved by the hand of a ghost – in only one direction.





Compact universalists

At this year's Hannover Messe, RINGSPANN will be devoting special attention to the FZ internal freewheels at its Booth D13 in Hall 25. These maintenance-free freewheels are able to cover a broad spectrum of applications in particular thanks to their "ball bearing properties". They feature bores with diameters of up to 40 mm and are suitable as standard for use under normal operating conditions. Depending on the requirements, there are versions where the torque is transferred via press fit or keyway connection on the inner ring or on the outer ring of the freewheel. In the indexing function, RINGSPANN'S FZ internal freewheels are for example frequently used as a pair in the infinitely variable gearboxes of metering rollers of agricultural machinery, filling plants or food processing machinery: Two cam disks that are set off are arranged on the input shafts of the gearbox, which drive the outer rings of the two FZ freewheels by means of lever arms, which then gradually turn the metering shaft. The compact RINGSPANN freewheels of the FZ series can also be found in the drive systems of many packaging systems, conveyor belts, labelling and textile machines. They have even been installed in hybrid drive concepts of environmentally friendly vehicles within the scope of various research projects. "In their drivetrains, they ensured through the alternating function between idle and driving operation that rotors did not turn when being pushed and that the vehicles could easily continue to roll during switching", explains RINGSPANN divisional manager Thomas Heubach.

Ready for installation and food grade

RINGSPANN delivers the freewheels of its FZ series ready for installation with grease filling for integration in customer housing. The freewheels are also available with food grade lubricant for use in food technology or other hygiene-sensitive areas of application. FZ freewheels with both-sided seals made of acrylonitrile butadiene rubber (2RS sealing) will also be on display at Hannover Messe – this, too, a parallel to the series 62 standard grooved ball bearings according to DIN.

By the way: The entire range of freewheels in the FZ series can be found in the current offer in RINGSPANN's online shop, plus many other models and types of internal freewheels. Overall, designers and technical purchasers can choose from twelve models of freewheels on this modern Internet platform (www.ringspann.com). <<



Safety and efficiency in the drivetrain

RINGSPANN's ongoing productive offensive in the field of non shiftable shaft couplings since Autumn 2018 has been very well received by designers and developers in industrial drive technology. Thanks to the completion of existing models and the incorporation of new coupling types in its overall range, the company now offers many alternatives for the realisation of safe connections between the various units and components in the drivetrain. At Hannover Messe, RINGSPANN will be providing a glimpse into its current shaft coupling portfolio. At the centre of its exhibition programme are elastic elastomer jaw couplings for dynamic applications.

What RINGSPANN has to offer designers and engineers in industrial drive technology since October 2018 in the field of non shiftable shaft couplings is rich in alternatives: A selection of eight models with nominal torques ranging from 2.0 to 1,299,500 Nm, spanning almost all technically relevant shaft coupling types that you need in industrial drive technology to compensate axial, radial and angular displacements. Overall, the current RINGSPANN portfolios includes flange, flexible and cone clamping couplings, gear couplings, grid couplings and disc couplings, all the way through to pin-and-bush and jaw couplings. Product developers, engineers and plant manufacturers in all sectors are thus granted plenty of leeway for the design of rigid, torsionally stiff and elastic connections between shafts, motors, gearboxes and machines. At this year's Hannover Messe, RINGSPANN will be providing an overview of its expanded coupling range in Hall 25, Booth D13 by means of a number of exponents. The company hereby focuses particularly on the new jaw couplings of the REK series, which feature replaceable elements and spiders made of elastomers or synthetic rubber.

Fail safe and maintenance free

"The use of jaw couplings for elastic shaft connections is on the rise in Europe. They are fail safe and maintenance free, and are often significantly more compact in construction than

pin and bush couplings. Our new REK model is particularly interesting for manufacturers of pumps, compressors, ventilators, stirrers and belt conveyors, as well as for tool machines and crane trolley manufacturers – to name just a few key user groups", says Martin Schneeweis, the responsible product manager for shaft couplings at RINGSPANN. The current offer of the company ranges from the classic jaw couplings of the REK ... DCO series with curved spiders and nominal torques from 9.6 Nm, to the couplings of the REK ... DQO series with rectangular damping elements and nominal torques of up to 169,000 Nm. In terms of bore diameters – another key selection criterion for designers – these models range from 6.0 to 340 mm. All RINGSPANN jaw couplings also meet the explosion protection parameters in accordance with ATEX (Declaration of Conformity in accordance with ATEX 2014/34/EU).



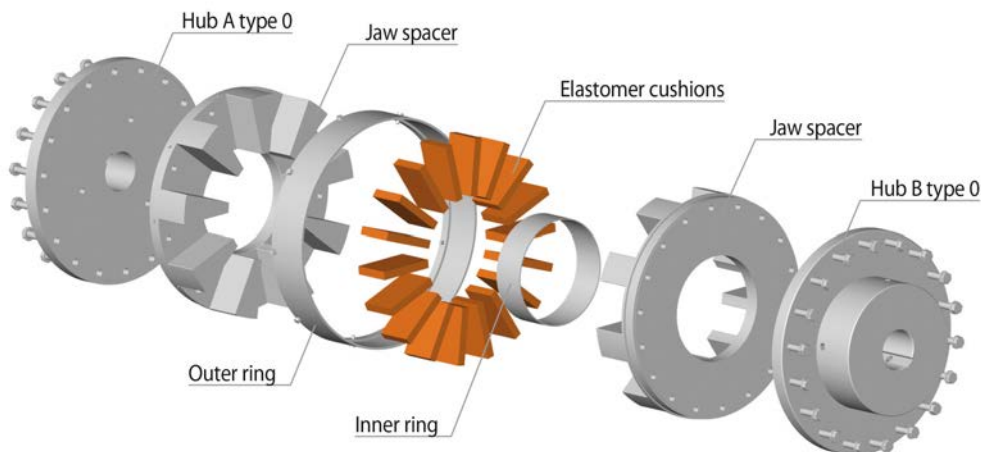

Quick switch and replacement

At RINGSPANN's Hannover Messe booth in Hall 25, designers and development engineers in industrial drive engineering can receive first-hand detailed information on which practical and functional advantages the jaw couplings offer. So you can find out, for example, that the elastomer damping elements with the couplings of the REK ... DQO model can be very easily and quickly replaced – without disassembling the drive-train. “The jaws, too, can be replaced quickly in the event of damage, since the hubs of the couplings are split and the drive plates can be removed radially”, says product manager Martin Schneewis.

With the ongoing product offensive in the field of non shiftable shaft couplings since Autumn 2018, RINGSPANN has achieved an important milestone on its way to becoming a one-stop supplier for high-grade components of drive tech-

nology. The company may have already been involved in the development and manufacture of safety and starting couplings for more than 60 years, and yet Martin Schneewis stresses: “The now completed expansion of our coupling range is as yet unrivalled in RINGSPANN's history”.

By the way: If anyone would like to get an overview of the new RINGSPANN portfolio of shaft couplings in advance of Hannover Messe, you can download the current product catalogue for free at www.ringspann.com. Here, all coupling types are listed by model and area of application: The cone clamping couplings and tru-line flange-couplings for rigid connections; the gear, disc and flexible couplings for torsionally stiff connections; the grid couplings for initially elastic and later torsionally stiff connections; and the pin-and-bush und jaw couplings for elastic shaft connections. <<



Martin Schneewis
*Product manager
 Shaft Couplings
 of RINGSPANN GmbH*

Preventive glimpses into the inner workings

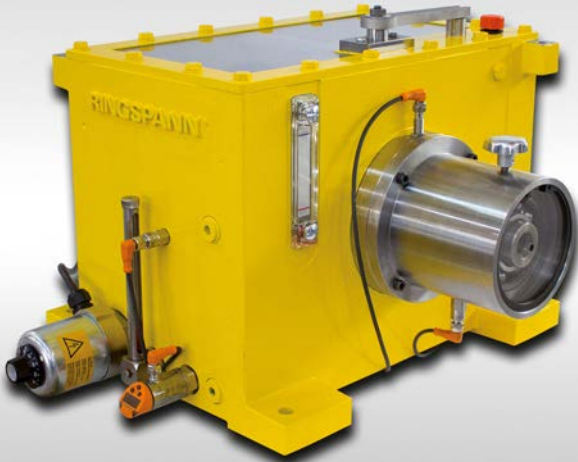

Practiced Industry 4.0 and genuine innovation: Using modern sensor technology and telematics, RINGSPANN has developed a condition monitoring system for housing freewheels. Operators of complex multi-motor systems and their maintenance staff now have the ability to predictively monitor all key performance and MRO parameters of the installed freewheels - in real time and from a distance. Data analysis, remote maintenance and functional integration in super-ordinate control systems are included in the offer. This new tool for predictive maintenance will be presented for the first time at this year's Hannover Messe.

The housing freewheels of RINGSPANN's FH series are over-running freewheels and, with nominal torques ranging from 1,356 to 81,000 Nm, are used, for example, as automatic over-running clutches in drivetrains with multiple quickly-rotating motors or turbines. If one drive unit should fail, the FH decouples it from the drivetrain. The installation of complex switch-

ing equipment thus becomes unnecessary. This freewheel type is used among other things in pumps, generators, conveyor belts, ventilators or interruption-free power supplies. Depending on the complexity and number of drive systems, multiple FH freewheels can be installed in a single system, in some cases in difficult-to-access areas. To be constantly informed on what is going on inside the freewheels is thus of key importance for plant operators and their service teams. Within the scope of predictive maintenance, ideally around the clock, in real time and location-independent. RINGSPANN has incorporated these wishes of users - and more - into the development of the new condition monitoring system for its FH series housing freewheels. This innovation in freewheel technology will be presented to a large audience for the first time at this year's Hannover Messe in Hall 25 (Booth D13).

Comprehensive recording of all MRO parameters

In presenting this predictive maintenance solution for housing freewheels, RINGSPANN yet again underlines its technological leadership in this subsection of drive technology, drawing on modern telematics tools in addition to innovative sensor and diagnostics technology to realise it. The result is a practically-oriented comprehensive solution that gives the user a complete overview of the current functional and kinematic status of each housing freewheel integrated in the condition monitoring system. All MRO-relevant operating temperatures and performance parameters are recorded for this purpose: Thermal sensors measure heat development, inductive sensors monitor the speeds of the input and output shafts, vibration sensors determine the bearing condition and intelligent diagnostic electronics act as an early warning system. For detailed analysis and interpretation, all data can be transferred via remote maintenance directly to the RINGSPANN service centre. From there, feedback is given in the form of clearly structured production and efficiency graphs.

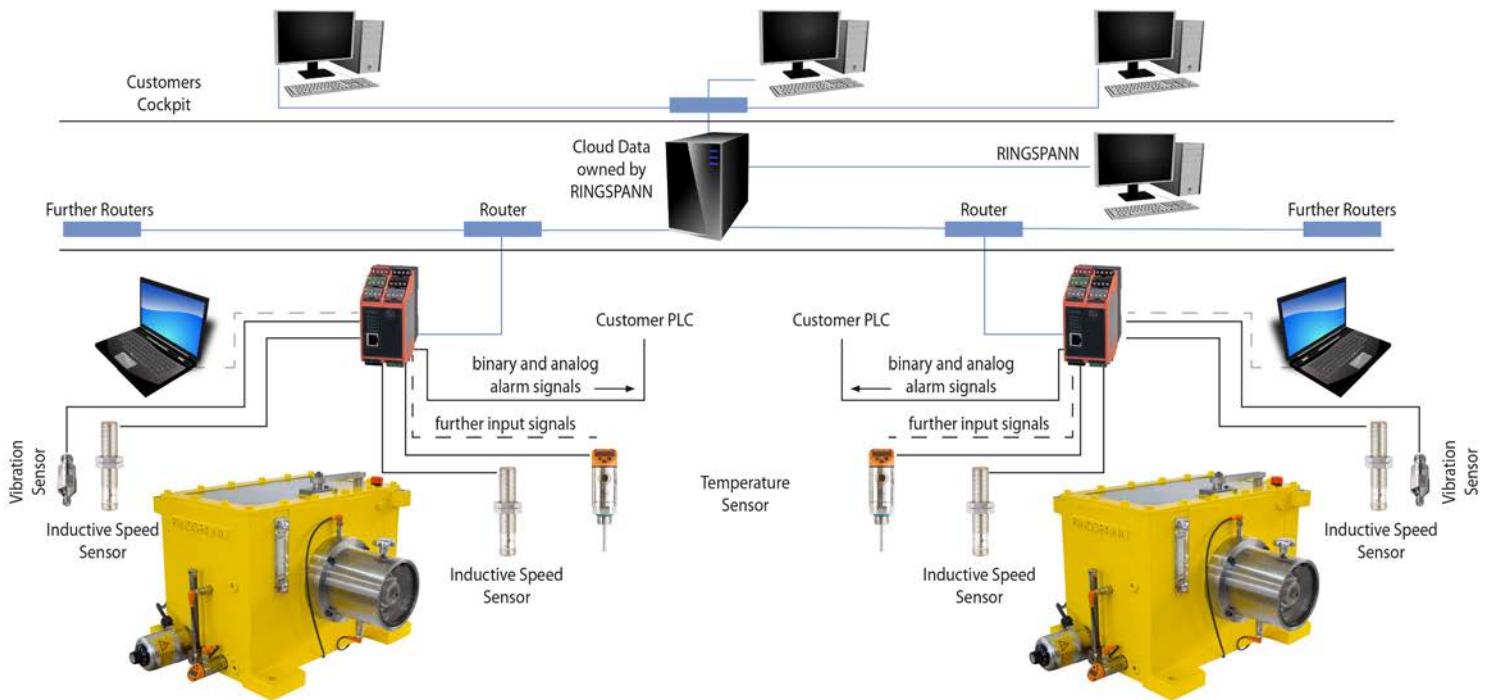

Keeping an eye on everything around the clock

The plant operator or maintenance technician can follow MRO-relevant events in the freewheel on their screen, tablet or smartphone: World maps and country maps highlight the locations of the freewheels being monitored, traffic light symbols provide a visual representation of the situation and the functional status of all the sensors, and coloured diagrams provide information on any damaging vibrations and the adherence to vibration limits. Warning lights start to blink as soon as any functional difficulties arise inside the housing freewheel or when a critical condition is reached.

The practical benefits of the new condition monitoring systems from RINGSPANN cannot be overstated. It primarily provides maintenance technicians and plant operators with a powerful tool that enables them to react immediately to urgent events in the housing freewheels – and then also in the entire drivetrain: To prevent impending damages and malfunctions, to prevent expensive consequential damages, or to check any repairs that have been carried out. As a secondary effect, however, thanks to its WWW remote maintenance and the active integration of the company's in-house freewheel analysts, the new RINGSPANN system also clears the way for further drive technology process optimisation and improving plant availability. It furthermore creates the basis for targeted vulnerability assessments, and not least enables a relaxed view towards remaining service lives and the planning of maintenance intervals and repair works.

Crash simulation at Hannover Messe

The new RINGSPANN condition monitoring system for housing freewheels is not designed as a singular stand-alone product, instead it is designed for integration into superordinate production or service control systems. Modern network and internet technologies are thus an integral element of the overall package. At its Booth D13 in Hall 25 at this year's Hannover Messe, RINGSPANN will be showcasing this new Industry 4.0 predictive maintenance solution by means of a concrete example: It will show various typical damage events being simulated on a medium-sized FH housing freewheel – integrated into the new condition monitoring system – with a nominal torque of 5,500 Nm. Just like in MRO practice, the trade fair visitor will then be able to follow events inside the freewheel live via tablet PC. <<

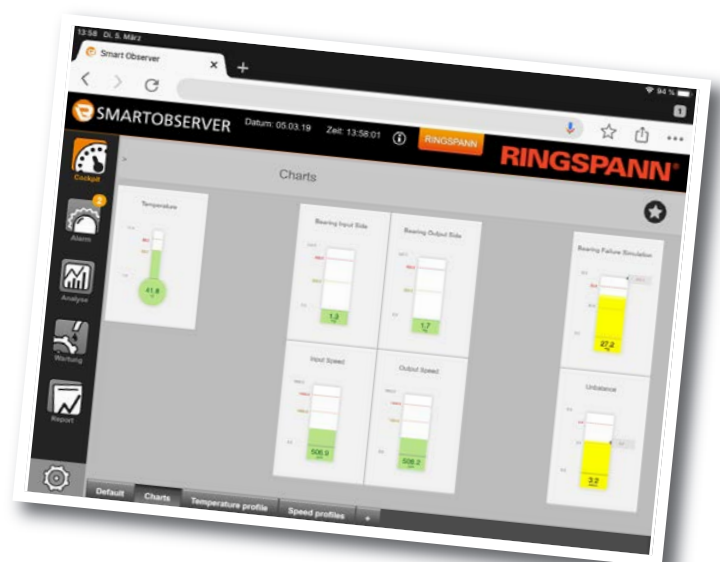

May

Unhindered market access to the USA and Canada



Franz Eisele
*Head of Division
Brakes and Couplings
at RINGSPANN GmbH*

The electromagnetic disc brakes from RINGSPANN rank among the essential components of countless drive systems in mechanical engineering and plant construction. They can be deployed for stopping, control and holding and cover a very large application spectrum with braking torques ranging from 94 to 6,590 Nm. These compact industrial brakes received their UL and CSA certifications just a few days ago. That makes it easier for all export-oriented manufacturers to gain access to international overseas markets - particularly those in North America and Canada.

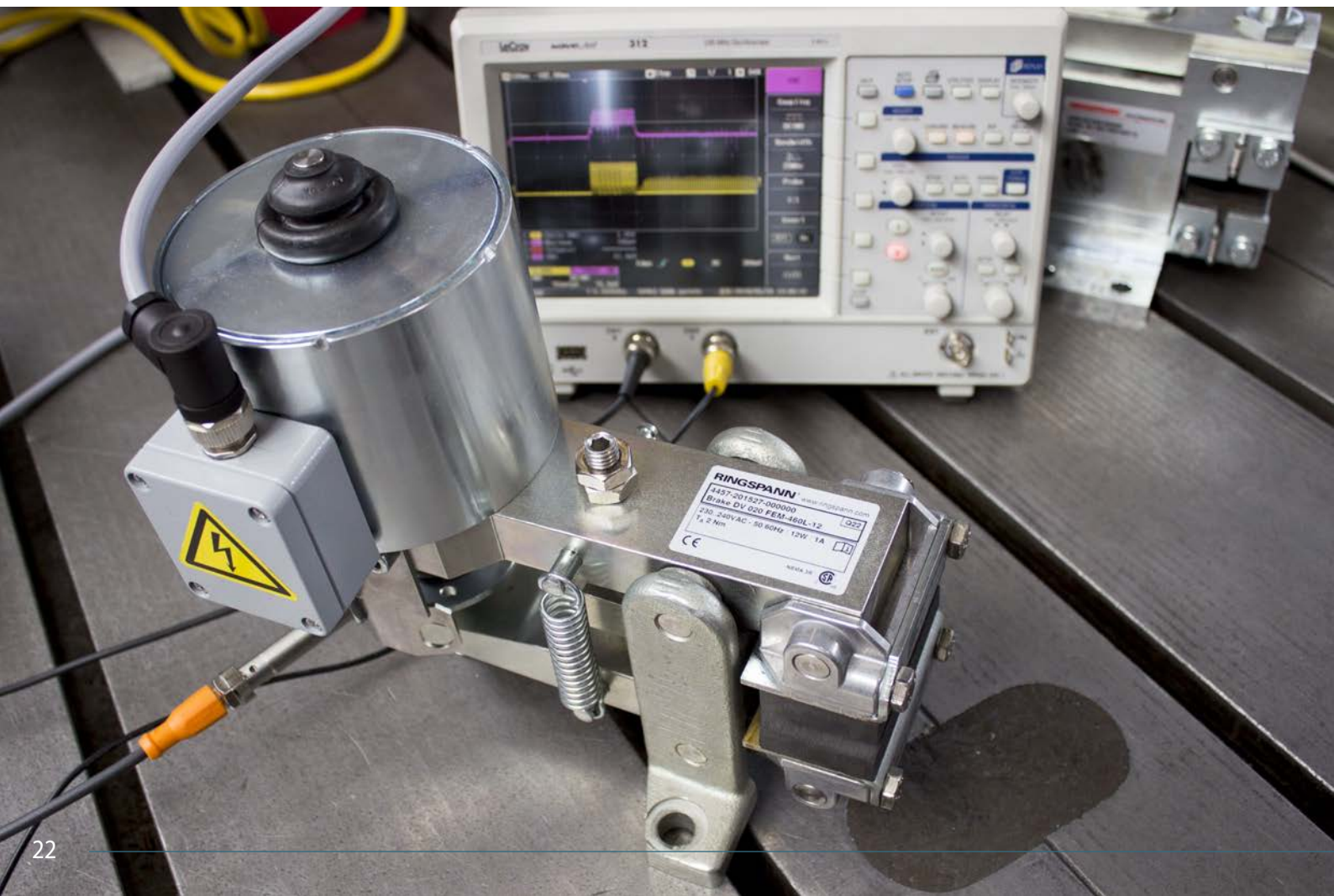

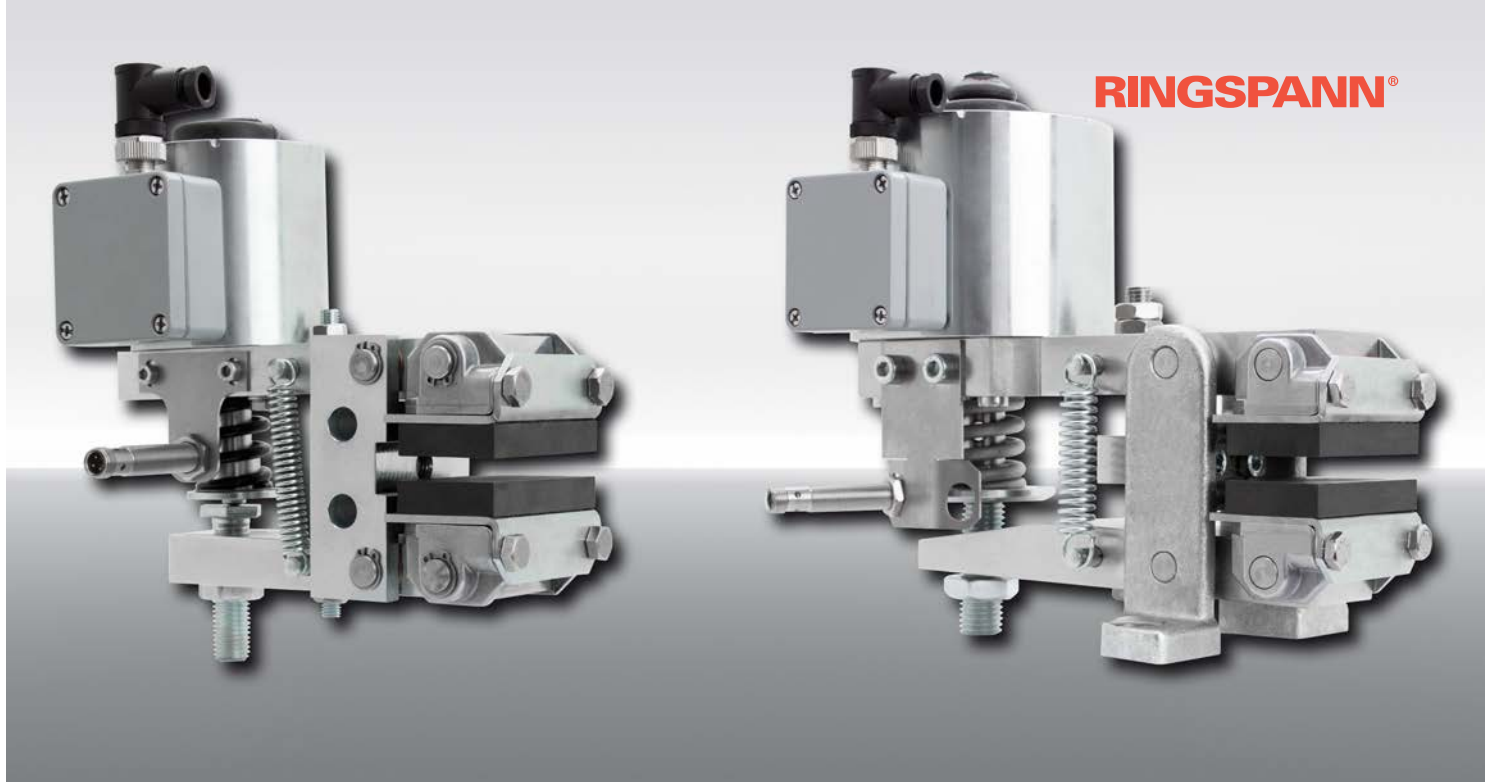

For mechanical engineers and plant manufacturers who directly or indirectly deliver to North America or Canada, the seals of approval from the *Underwriters Laboratories (UL)* and the *Canadian Standards Association (CSA)* are among the most competitively relevant labels. They may not be mandatory; however, they greatly facilitate and accelerate access to the markets on the north American continent and many other overseas regions. RINGSPANN therefore recently had the electromagnetic disc brakes from its DH and DV series certified according to the criteria of UL and CSA. The EV and EH series are also poised for certification. That would make all spring activated RINGSPANN disc brakes that are electromagnetically released for braking torques ranging from 94 to 6,590 Nm perfectly equipped to be exported obstacle-free into the USA and Canada. "For German and European manufacturers who want to successfully gain a foothold in these regions with their systems, machines or drive units, the use of components with UL and CSA approval is a strategic competitive factor. And that is because, quite similar to our CE label, it confirms the adherence to safety standards", explains Franz Eisele, who heads RINGSPANN's brakes and clutches division.

Strict specifications by list

To be certified by the UL in Northbrook (Illinois), USA and the CSA Group – they have their European office in Frankfurt am Main – a product may only have materials or components installed that are listed by these two standards bodies. The adherence to this requirement is among other things also checked through test series. "Since it is therefore hardly feasible to retrospectively have existing products certified, we have deployed new magnets and new electronics for our

compact electrical brakes. That made it possible for us to create the prerequisites for UL and CSA certification", reports RINGSPANN divisional manager Franz Eisele.

The electrical alternative

RINGSPANN's electromagnetic disc brakes from the DH and DV series and the EV and EH series cover a very large application spectrum in mechanical engineering and plant construction. They convince particularly as a space-saving and low-maintenance alternative to hydraulic and pneumatic brake systems. Typical areas of deployment for these electrical brakes are for example the turbine, ventilator and fan industries, machine tool construction, winch and winding technology, wind power technology and general drive technology. The (emergency) stop function brings rotating shafts to a standstill within seconds, as a control unit they enable the controlled adherence or delay of defined forces, and as a holding system they prevent the unintended start-up of rotating components.

The electromagnetic RINGSPANN disc brakes can be installed in any position and can also be operated in synchronised groups. The DH and DV series feature electrical brakes with braking torques ranging from 94 to 570 Nm; the EV and EH series meanwhile feature braking torques ranging from 65 to 6,590 Nm. A remarkable technical feature of RINGSPANN's EV and EH brakes is that they only have an extremely low power consumption for the entire holding phase. "The smaller sizes only require 10 watts", stresses divisional manager Franz Eisele. With such excellent performance figures, the Homburg manufacturer is setting international standards and making a tangible contribution towards creating energy-efficient drive solutions. <<

Smart switching between motors

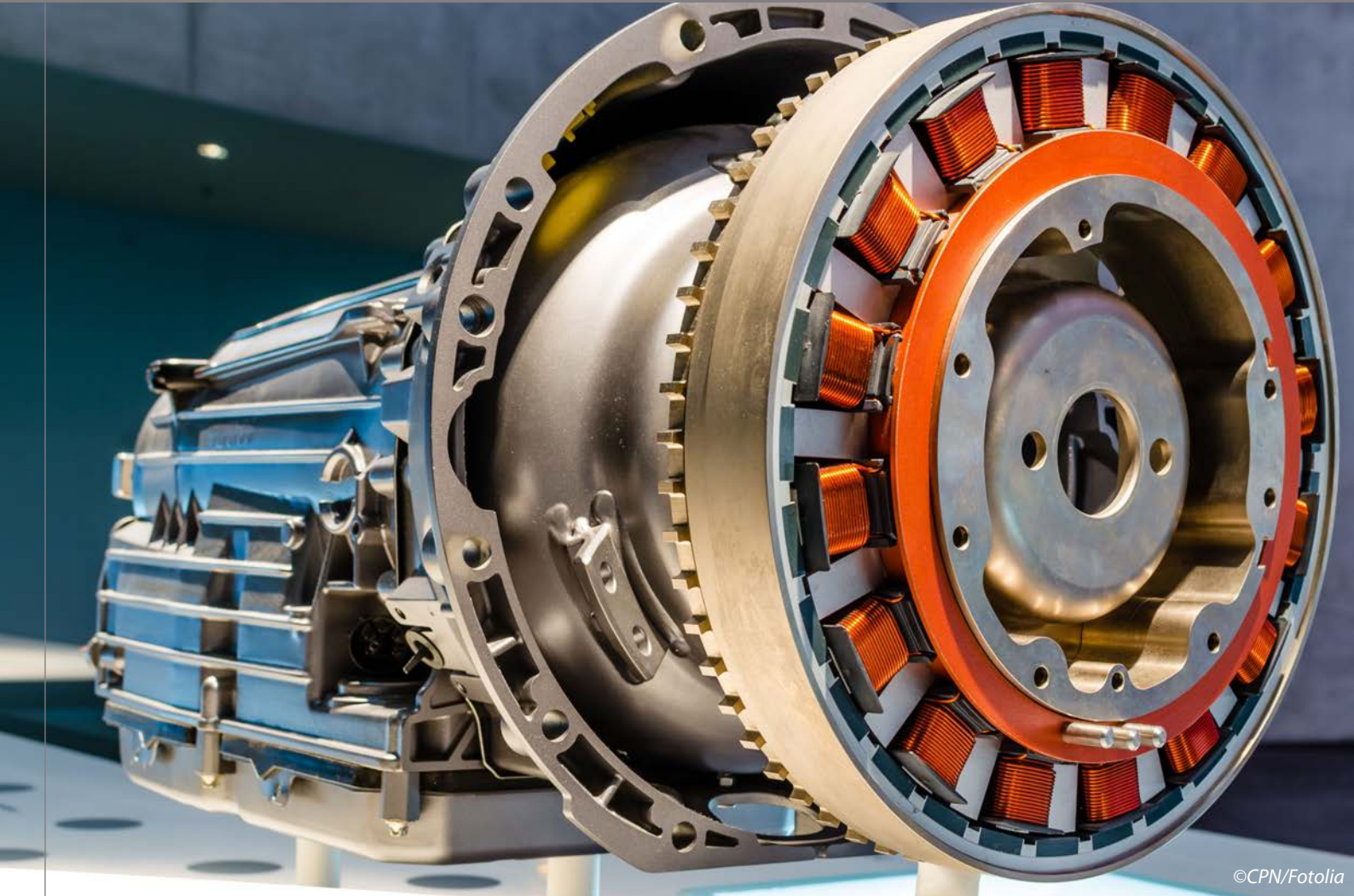

©CPN/Fotolia

With its overrunning freewheels, RINGSPANN offers designers of hybrid drive systems in mechanical engineering and plant construction a clutch coupling solution that is both uncomplicated and reliable. Without elaborate control technology, these installation-ready components are able to control the differences in speed between electric and combustion motors or alternately engage and disengage different motors of a single drivetrain. Read how the manufacturers of cranes, turbines and fans employ RINGSPANN's overrunning freewheels to realise hybrid drive systems.

Overrunning freewheels from RINGSPANN are compact and low-maintenance installation components that make it possible to engage and disengage entire machines or individual units of hybrid drivetrains. The engaging takes place with torque transmission in driving operation of the freewheel, the disengaging with torque interruption, meanwhile, in idling operation. Both take place without any additional (and expensive) regulating or control technology, because the overrunning freewheel is a purely mechanical function module. They can be used as a space-saving and safe clutch coupling or to regulate deviating speeds of electric and combustion motors in joint or parallel drivetrains. The use of overrunning freewheels in such hybrid drive systems has become widespread in mechanical engineering and plant construction.

Between turbines and pumps

Energy recovery turbines (ERT), for example, are among the standard units in many hydro and power plant engineering systems. These are single or multi-stage pumps or turbines that aim to optimise the effectiveness and efficiency of the systems. To achieve this, an ERT uses the energy surplus from fluid engineering processes to power a neighbouring system via a shaft connection. This means that instead of subsequently throttling the liquid pressure built up in a process engineering process through a pressure reducing valve – which would be trivial and wasteful – the ERT taps this “stored” energy from the system and provides it for further use. This creates a hybrid drive solution, where a considerable part of the energy that is originally fed in is kept and transferred to a second use. And how does this energy transfer work? With the help of an overrunning freewheel, of course, which couples the output shaft (output) of the energy recovery turbine with the drive shaft (input) of the secondary drive. “The freewheel is assigned with the task of relieving the receiving side – that can be a second motor – since it needs to be driven with less energy”, explains Thomas Heubach, the head of RINGSPANN’s freewheels division. In practice, many designers employ, for example, RINGSPANN’s FH or FKHG series housing freewheels with hydrodynamic sprag lift-off or the complete freewheels from the FB series with various sprag types.



Thomas Heubach
Head of Division Freewheel
of RINGSPANN GmbH

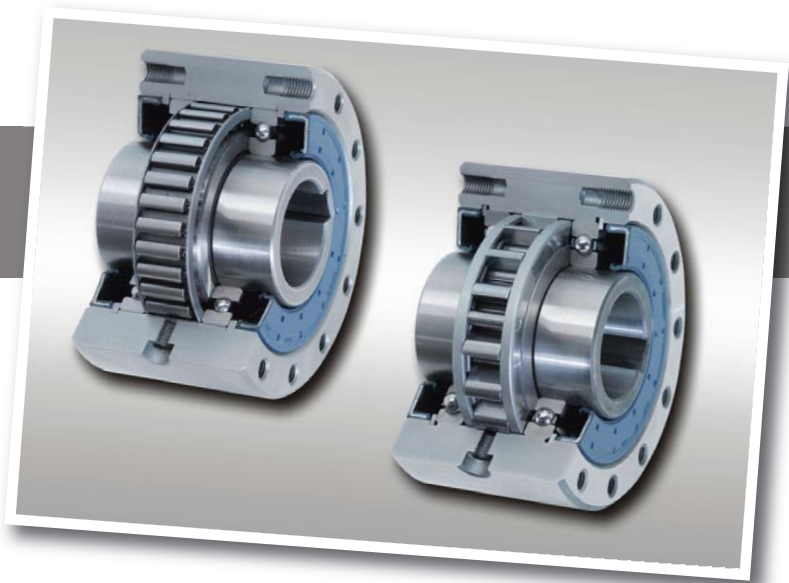

Between drive and expander

Another case in which hybrid drive technology serves the aim of energy recycling is the construction of expanders to transform the thermal energy of hot fumes into mechanical force. Such expanders are used among other things in the petrochemical systems of Fluid Catalytic Cracking technology and make it possible to use the thermopower gained to mechanically drive a generator or a regenerator air fan. The expander itself, too, often benefits from the energy fed back because it is used to support its main drive. This significantly improves its energy balance. “In such applications, our overrunning freewheels sit between the hot-air turbine of the expander and its main drive, which, depending on the type of system, can be an electric or combustion motor. As soon as the main drive reaches a higher speed than the expander, the freewheel disengages both units from one another”, says RINGSPANN divisional manager Thomas Heubach. To make it as easy as possible for the designers of the expanders, RINGSPANN supplies its overrunning freewheels not just as installation-ready components, but alternatively also as construction sets. Here, the customer can construct the shafts and freewheel elements (inner/outer rings, sprags, bearings etc.) into its assembly group – for example a high-speed gearbox – in a space-optimised manner. “However, this assumes that the respective customer possesses comprehensive expertise in the field of freewheel technology”, says Thomas Heubach.

June

Between main and auxiliary drive

The use of overrunning freewheels from RINGSPANN in drive systems of large fans is widespread – for example in tunnel or mining construction. They can be hybrid solutions or systems with motors of the same type. Frequently, these powerful fans are alternately driven by one, two or even three electric motors. Two drives perform – solo or as a duo depending on the power requirement – the main work, while a third motor is only used for slow operation for repairs or inspections. The task of the overrunning freewheels then consists in engaging and disengaging the motors on the ventilator of the fan automatically and where required. RINGSPANN usually supplies its FH series housing freewheels or also complete solutions – so-called Smart Solutions – consisting of freewheels and overload clutches for such applications.

Another application closely related to the fan application is where overrunning freewheels with a housing again assume the alternate switching on or off of the motors: The hybrid drive systems of induced draft fans. This normally involves electric motors with outputs of 400 kW and 800 kW being used in solo or duo operation in combination with combustion motors. RINGSPANN's housing freewheels are situated between the induced draft fan and the motors and couple the respectively operating drive fully automatically with the fan. "The electromagnetic brakes integrated in the freewheels hereby prevent the still-standing drive from being dragged along", stresses RINGSPANN divisional manager Thomas Heubach. If, moreover, a slow-speed drive is provided for slow turning to cool off the rotor, an additional overrunning freewheel with type-z centrifugal force lifting-off sprags is used. It engages at a low speed and switches into freewheeling mode as soon as the system reaches its operating speed.





Between diesel and electric

Illustrative examples for the use of overrunning freewheels in hybrid drive systems can also be found in crane and shipbuilding. In mobile, stacking and container cranes you will most commonly find a diesel and an electric motor, which together or alternately drive the crane. Sometimes the diesel engine does the work and the electric drive serves as a generator – in this case, the freewheel couples the drivetrain together. If the electric motor takes control and the diesel takes a break, the freewheel disengages the drivetrain. In shipbuilding, the use of overrunning freewheels enables the switching from diesel drive to electric motor drive in the harbour – quiet, precise and environmentally friendly.

At RINGSPANN, a significant trend has been observed for a long time now towards more hybrid drives in many areas of mechanical engineering and industrial vehicle technology. Divisional manager Thomas Heubach also strongly believes “that hybrid drive technology is a rapidly growing market for our overrunning freewheels. Particularly because it produces extremely smart solutions thanks to the relatively simple mechanics, which are very easy to service, as they make do without any electronics.”

By the way: RINGSPANN'S entire range of freewheels can be found in the company's current online shop offer at www.ringspann.com. <<

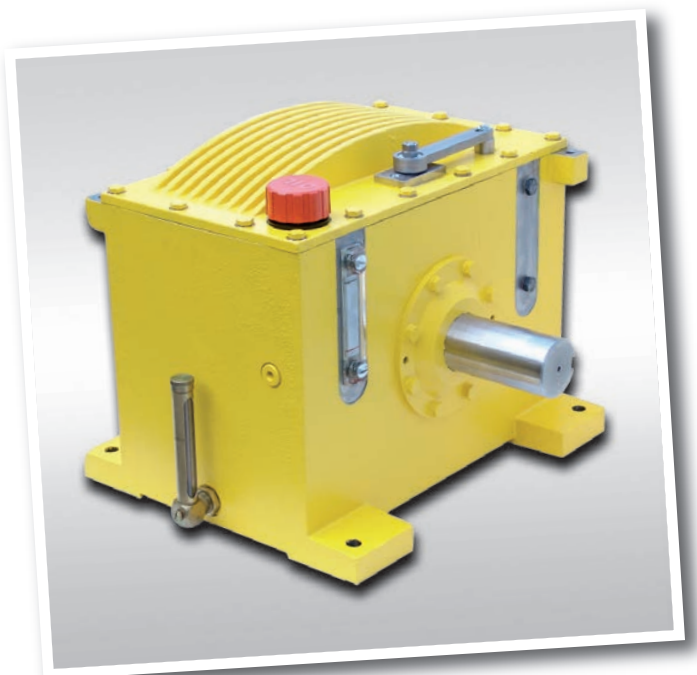

Conformal projection to the thousandth

Among the highlights from RINGSPANN's appearance this year at EMO is the new clamping coupling for the fixing of driven rotary/swivel tables in multi-axis machining centres. Shortly after first being presented last Autumn, this mechanical, hydraulic high-precision solution has established itself as the favourite of countless renowned manufacturers of tool machines and rotary/swivel portals. With its exceptional conformal projection and holding torques of up to 2,400 Nm, it significantly exceeds the performance capacity of conventional clamping systems.

In the coordinate field of modern tool machines and machining centres, rotary/swivel tables and portals position the A and C-axes. Their kinematic task is to support the precise and fast approach of the workpiece into any required angle setting. To achieve this, the positioning axes with the latest generation of rotary/swivel tables are driven by torque motors that can be controlled directly and with a high degree of precision. When they take up their defined angle settings, they are clamped in tightly and must hold their position securely under stress during machining. The market offers a range of different clamping systems to realise this. Continuously increasing demands of the user with regards to achievable accuracies and transmissible torques, however, mean that manufacturers of rotary/swivel tables and machine tool manufacturers are increasingly looking for more powerful clamping systems for their positioning axes. At RINGSPANN, this trend was identified at an early stage and a new clamping coupling was developed for the clamping of rotary/swivel tables, which should soon replace many well-known clamping system products. Several renowned mechanical engineers have since taken notice of the new clamping coupling and are planning for their deployment. And for good reason: With a maximum torsion angle of just 0.007 degrees, a holding torque of up to 2,400 Nm and a very high torsional stiffness, the new RINGSPANN clamping coupling paves the way for implementing the highest precision and force demands when fixing the driven positioning axes of rotary/swivel tables in tool machines.

Mechanically clamped, hydraulically released

At this year's EMO, trade fair visitors to RINGSPANN's Booth E22 in Hall 3 can learn directly about the advantages and features of the innovative precision clamping coupling. One of the things they will discover is that it employs high-quality clamping discs from the RINGSPANN range to transfer the axial force of screw plate pressure springs into a radial force and taper a specially designed, ring-shaped deformation element. This purely mechanical action ensures a fully anti-twist, all round clamping of the kingpin of the positioning axis. The clamping is quickly released by applying 115 bar of hydraulic pressure to the clamping coupling. This immediately frees the positioning axis of the rotary/swivel table again for the approach into the next angle setting. The new high-precision



solution from RINGSPANN thus also supports quick changes between different angle settings of a machining process.

Clamping fixture innovations in Hannover

Besides the new clamping coupling for rotary/swivel tables, at this year's EMO in Hannover (16.-21.9.2019) RINGSPANN will be presenting many more solutions from its comprehensive range of clamping fixtures. For example, precision clamping fixtures for the mechanical processing of cylindrical internal and external surfaces, which are widely available as standardised complete clamping fixtures. They are available in numerous versions, so the customer can choose between flange chucks and flange mandrels in the construction forms of bonded disc, taper collet, taper sleeve and flat element. With true running accuracies of $\leq 10 \mu\text{m}$ these clamping fixtures are ideally suited for demanding tasks in machining technology.

A major attraction at RINGSPANN's EMO booth in Hall 3 will in all likelihood once again be the innovative expanding sleeve mandrel HDDS. This economical clamping mandrel alternative to hydraulic expanding clamping tools in gearing technology and fine machining stands out thanks to true running accuracies of $\leq 5 \mu\text{m}$, takes up workpieces with bores of up to tolerance class IT10 and reduces the costs for feeding and positioning technology in fully automated operation. Depending on the version, the HDDS can clamp bores from a diameter of 23 mm. <<

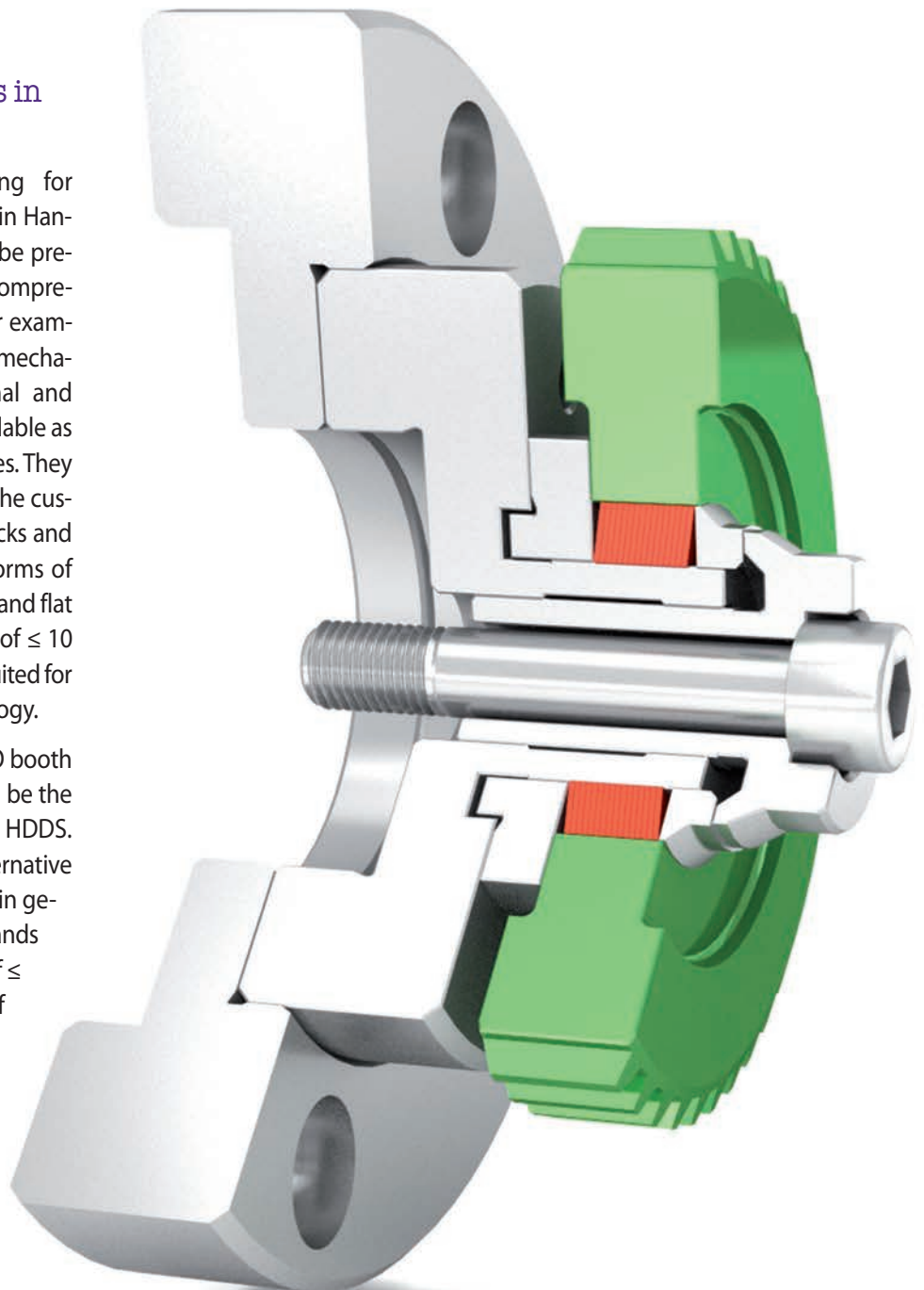

August

More play in gearing



Volker Schlautmann
*Head of Division
Clamping Fixtures of
RINGSPANN GmbH*

Manufacturers of gear cutting machines and users in the field of fine machining should make a beeline for Booth E22 in Hall 3 at this year's EMO. Here, RINGSPANN will once again be presenting the youngest star of its comprehensive clamping fixture range: The mechanical expanding sleeve mandrel HDDS. As a both precise and flexible alternative to hydraulic expanding clamping tools, it has since provided multiple examples of its performance capability in various gear wheel assemblies. It is currently under discussion by the first manufacturers to become part of the standard configuration of their gear cutting machines.

Increasing demands on accuracy have for years determined the mechanical production of spur or taper wheels for gear manufacturing. While gearing qualities of 8 or 9 in accordance with DIN 3961 used to be viewed as sufficient for most applications in this area of fine machining, today clients often write qualities of 7 or 6 into the product specification of their suppliers. Even higher are the demands on gear wheels for mo-

torsports – here, gearing qualities of 5 or 4 have long since become standard. “The clamping tools deployed during machining – in addition to the machines and tools – play a key role in achieving such qualities. Ideally, they support gearing technicians not only when fulfilling increasing quality demands, but also offer them more manufacturing flexibility and economic leeway”, says RINGSPANN’s Volker Schlautmann. Visitors of this year’s EMO will get a glimpse of how the concrete proposal of the head of sales and design of the company division clamping fixtures looks in Hall 3 at Booth E22. Because that is where RINGSPANN will once again be showcasing the latest star of its current clamping fixtures range: The mechanical expanding sleeve mandrel HDDS.

More flexibility thanks to greater expansion

The HDDS by RINGSPANN is an innovative inner clamping system and the mechanical alternative to the hydraulic expanding clamping mandrels which are widespread in gearing technology. It stands out thanks to its true running accuracy of $\leq 5 \mu\text{m}$ and achieves an absolute expansion that is four times larger than most hydraulic clamping fixtures. Volker Schlautmann tells us what this means for the user: “Our HDDS can take up workpieces with bores of up to tolerance class IT10. Most hydraulic clamping fixtures, meanwhile, are only suited to take up workpiece bores up to tolerance class IT7.”

Unlike hydraulic expanding clamping mandrels, RINGSPANN’s purely mechanical expanding sleeve mandrel offers an additional key advantage: Its use is completely free of leakage risks. This provides more process safety in series production, since even the smallest leakages of hydraulic clamping fixtures lead to process interruptions, malfunctions and increased repair outlay. The only source of wear for RINGSPANN’s HDDS are its clamping discs. These are, however, quality products from our own production that furthermore can be replaced by the user. The clamping mandrel doesn’t need to be taken from the spindle to do so.

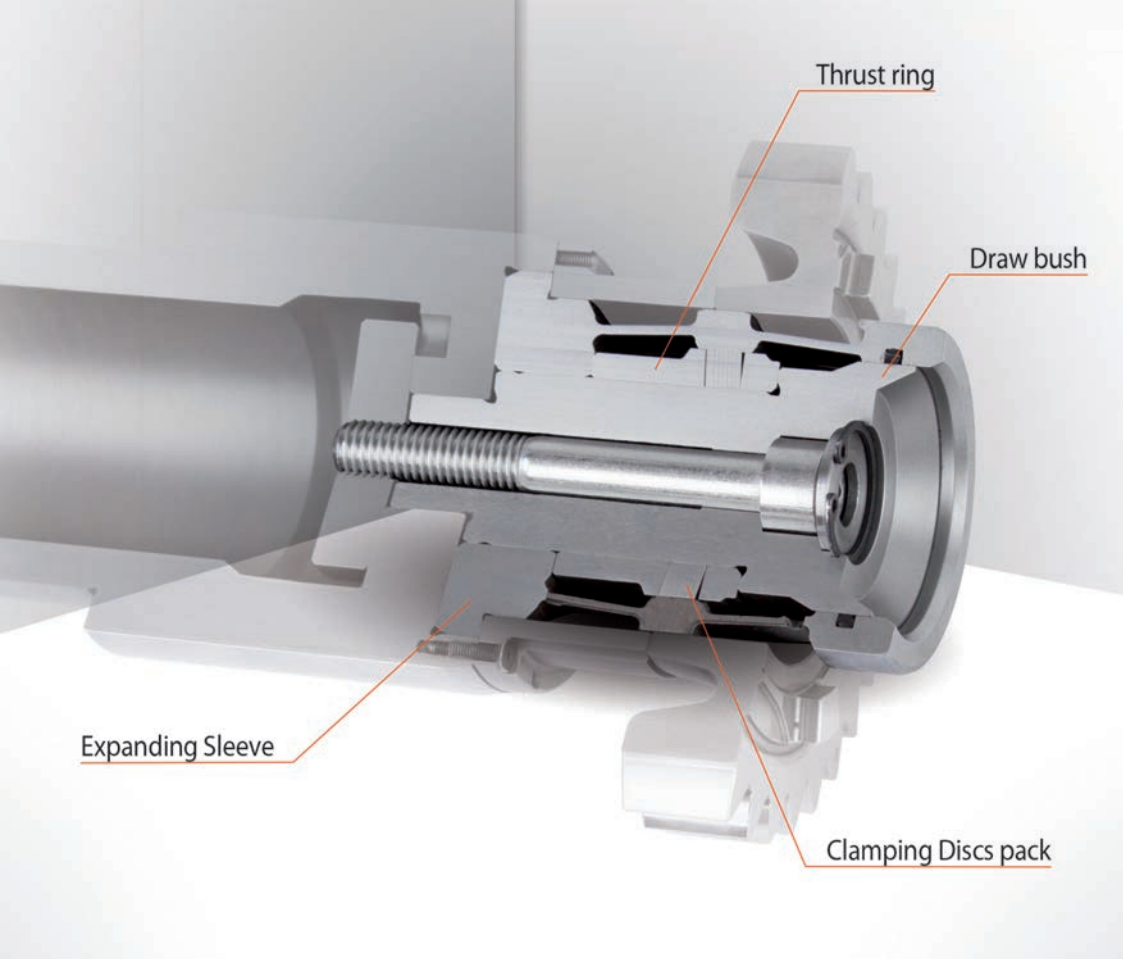

Advantages for users and mechanical engineers

Since its premiere at the end of 2016, the HDDS by RINGSPANN has already proven itself in numerous demanding applications in gearing technology. Among other things, it has been able to prove its performance capability in the production of a Swiss gear manufacturer in the high-precision grinding of spur wheels – metrologically documented! Volker Schlautmann reports: “The axial run-out and true running accuracy of our expanding sleeve mandrel was tested both using a control workpiece with a tactile measuring device accurate to the micrometre as well as on an original blank with a coordinate measuring system. In the test run, the measuring device showed $\leq 2 \mu\text{m}$ for the axial run-out and $\leq 3 \mu\text{m}$ for the true running, and with the series workpiece the achieved geometry accuracy of the involute gearing was significantly below the defined tolerance limits – the HDDS thus significantly exceeded the expectations of the customer.”

The expanding sleeve mandrel from RINGSPANN is now under discussion with Swiss and US manufacturers of gearing machines as a component of the factory standard configuration of their machines. The reason for this: It enables not only the realisation of high gearing qualities, but further facilitates the simple implementation of fully automated manufactur-

ing concepts. Clamping fixtures specialist Schlautmann explains: “For physical reasons, hydraulic expanding clamping mandrels exhibit a rather low expansion rate, which is why the handling systems used for their feeding demand a high degree of kinematic precision, which in turn requires rather high levels of investment in measurement and control technology of the periphery. This outlay is significantly reduced with the use of our HDDS, since it shows itself to be much more tolerant due to its high expansion rate.” The machines can be designed more simply and this paves the way for the user to gain a significantly more cost-efficient entry into fully automated processing.

Small diameters, short clamping lengths

Furthermore, the gearing technicians will discover at RINGSPANN's EMO booth in Hall 3 that the HDDS – depending on the version – can clamp bores from diameters of 23 mm and that it is even suitable for bores whose inner geometry is interrupted by a groove. An additional benefit: It is also a solution for the processing of workpieces with very short clamping lengths, because its mechanics perform a pull-back action, where the workpiece is pressed against a backstop and aligned. <<

Advertising motifs

WELLE-NABE-VE

Schrumpfscheiben • Konus-Spann
6,5 - 4 225 000 Nm

BREMSEN

hydraulisch • pneumatisch • elektrisch
0,5 - 325 000 Nm

FREILÄUFE

Rücklaufsperrern • Überholkupplungen • Vorschubfreiläufe
2 - 1 230 000 Nm



RINGSPANN®
Ihr Nutzen ist unser Antrieb

RINGSPANN®
Ihr Nutzen ist unser Antrieb

www.ringspann.de

ringspann.de

ringspann.de

SPANNZEUGE

Spannfutter • Spanndorne • Spannkupplungen
7 - 560 mm

WELLENKUPPLUNGEN

starr • drehstarr • drehelastisch
2 - 1300000 Nm

VERBINDUNGEN

Flanschelemente • Spannsysteme



RINGSPANN®
Ihr Nutzen ist unser Antrieb

gspann.de

RINGSPANN®
Ihr Nutzen ist unser Antrieb

gspann.de

RINGSPANN®
Ihr Nutzen ist unser Antrieb

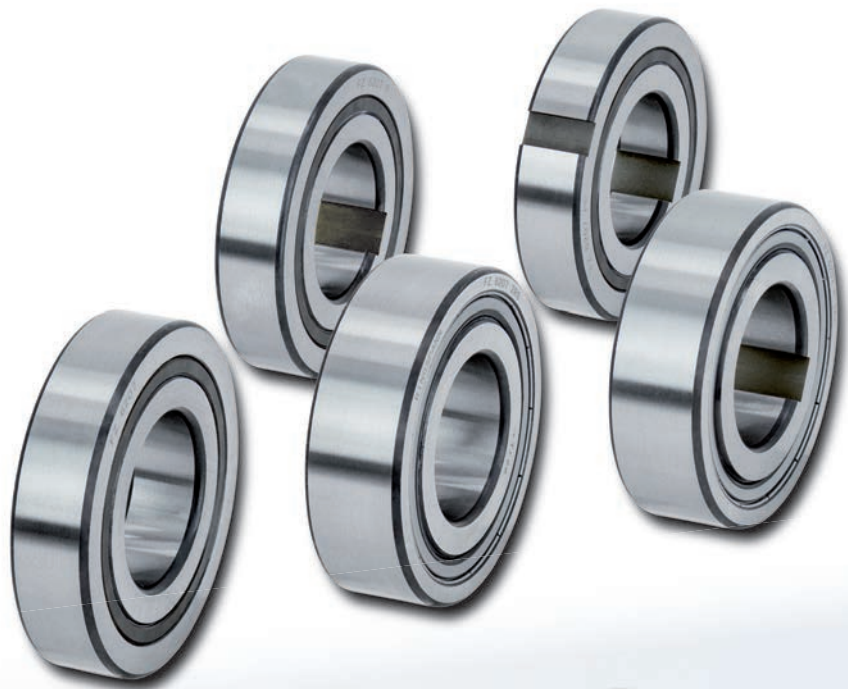
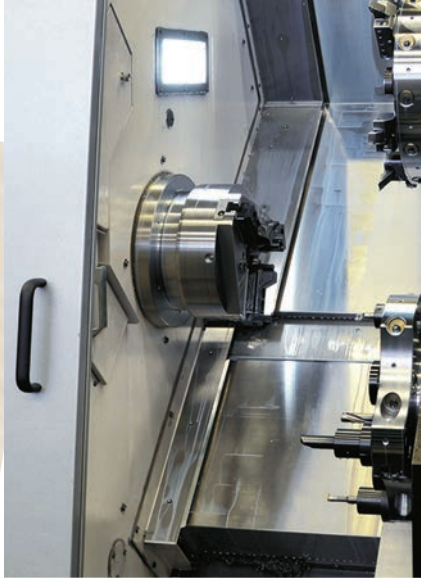

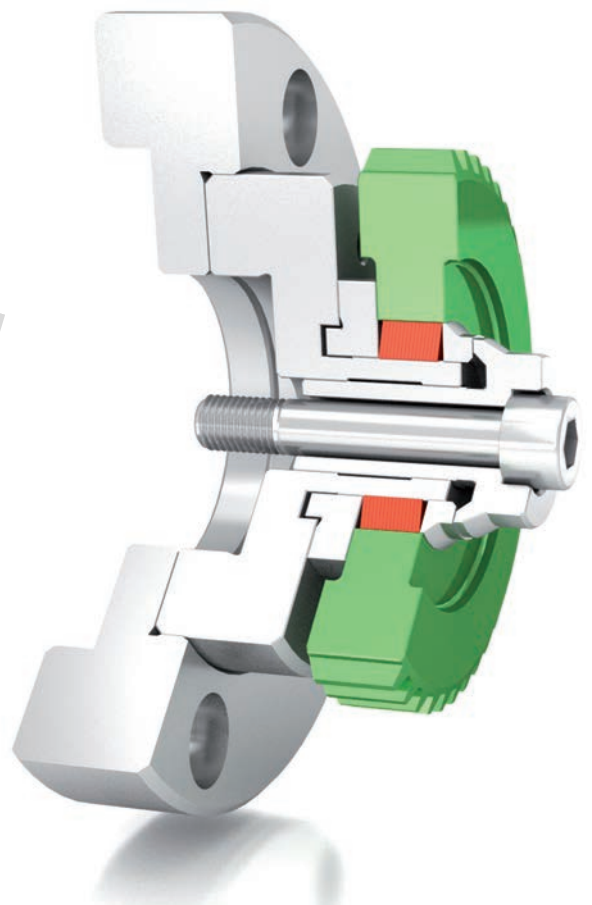
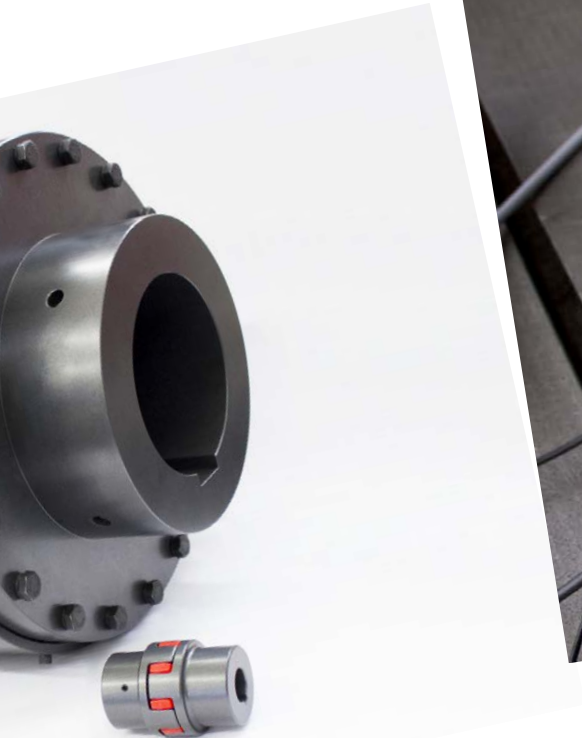
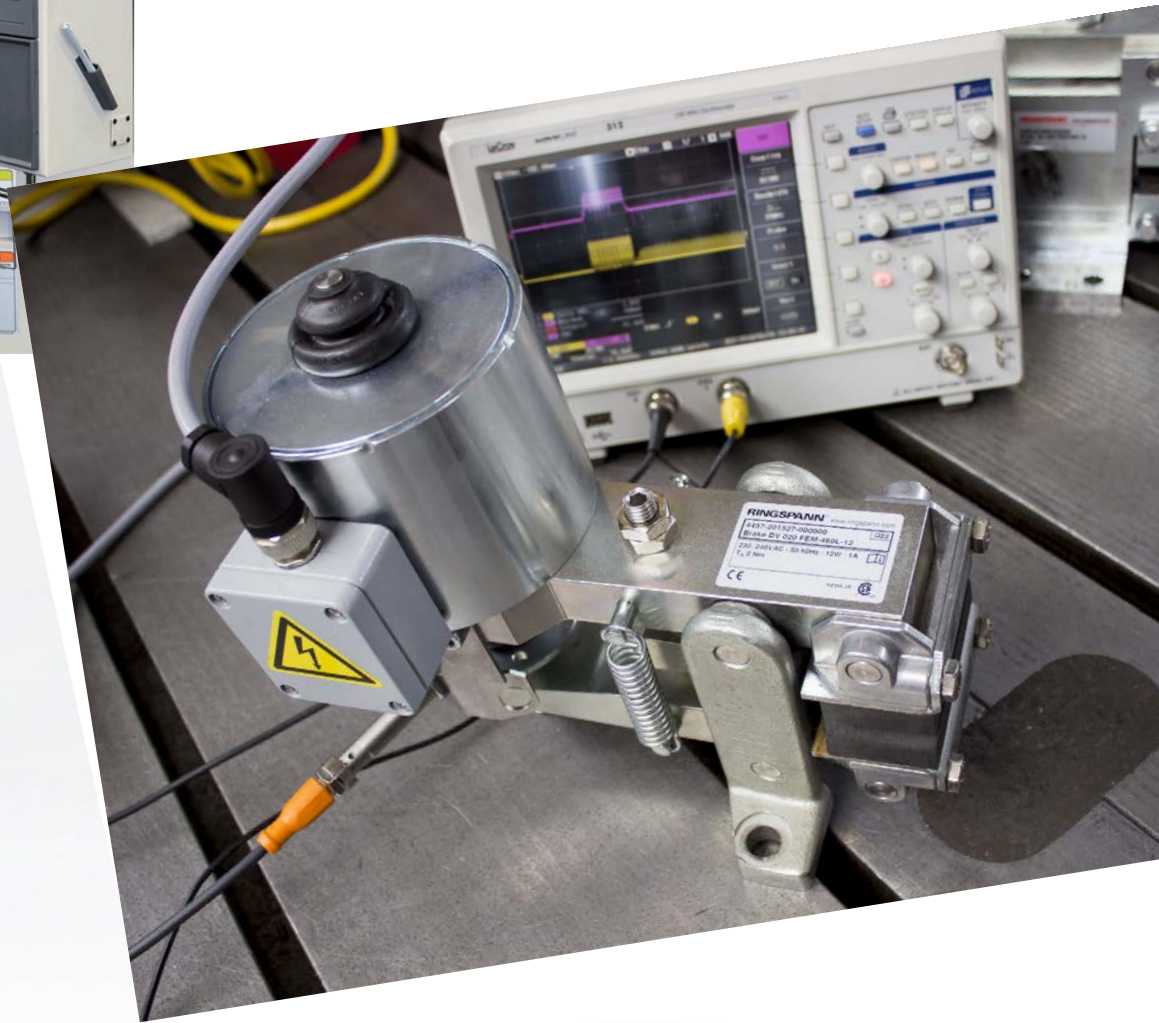

Publisher

RINGSPANN GmbH
Schaberweg 30-38
61348 Bad Homburg
Germany
+49 6172 275-0
info@ringspann.com
www.ringspann.com

Editorial staff

Graf & Creative PR
RINGSPANN GmbH

Layout

RINGSPANN GmbH

Photo credit

RINGSPANN GmbH
©industrieblick/Fotolia
©CPN/Fotolia
©eaumstocker/Fotolia
©bannafarsai/Fotolia